

ICM

SOLO/VCU, SELECT AND SYNC/ACU
MOTOR CONTROLS FOR EC MOTORS ON
FAN COIL AND BLOWER COIL UNITS

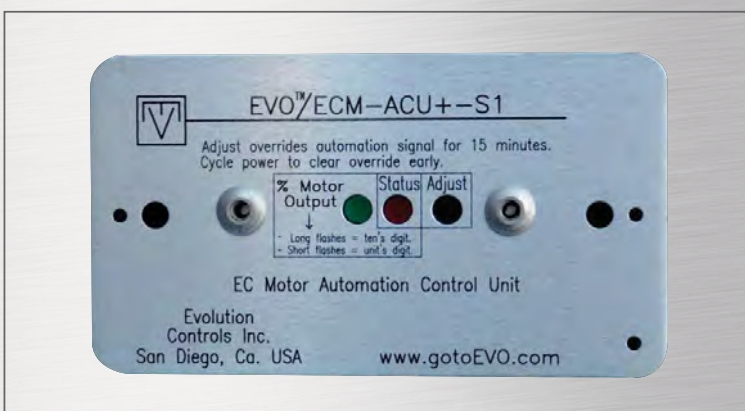

Installation, Operation, and Maintenance

TABLE OF CONTENTS

ELECTRONICALLY COMMUTATED (EC) MOTOR CONTROL WITH SOLO/VCU, SELECT AND SYNC/ACU PWM BOARDS. 3
PWM TROUBLESHOOTING GUIDELINES 7
EC MOTOR AND DRIVER 9
EC MOTOR TROUBLESHOOTING GUIDELINES 12

ELECTRONICALLY COMMUTATED (EC) MOTOR CONTROL WITH SOLO/VCU, SELECT AND SYNC/ACU PWM BOARDS

The Solo/VCU, Select and Sync/ACU PWM boards provide a pulse-width modulated (PWM) signal to the EC motor to control fan speed. The various PWM boards are used for different applications depending on the intended method to control the motor. The various boards are available on the products listed below:

1. Solo/VCU PWM – Single Speed, Manual Adjustment

2. Select PWM – Multi Speed, Manual Adjustment
3. Sync/ACU PWM – Proportional Speed (2-10VDC), External Adjustment

Input Power Specifications: 24VAC

Input Signal Specifications (Sync/ACU only): 2-10VDC (with jumper installed in "P" position)

Output Signal Specifications: 14VDC, 80Hz, Duty Cycle 0-100%

SOLO/VCU PWM (BLOWER COIL)

The Solo/VCU PWM board allows the user to control an EC motor using the potentiometer and feedback display on the front panel to adjust the input to the motor. The feedback display on the front of the

assembly displays the flow index, or % of PWM duty cycle being sent to the motor. The Solo/VCU PWM can be used with blower coil units.

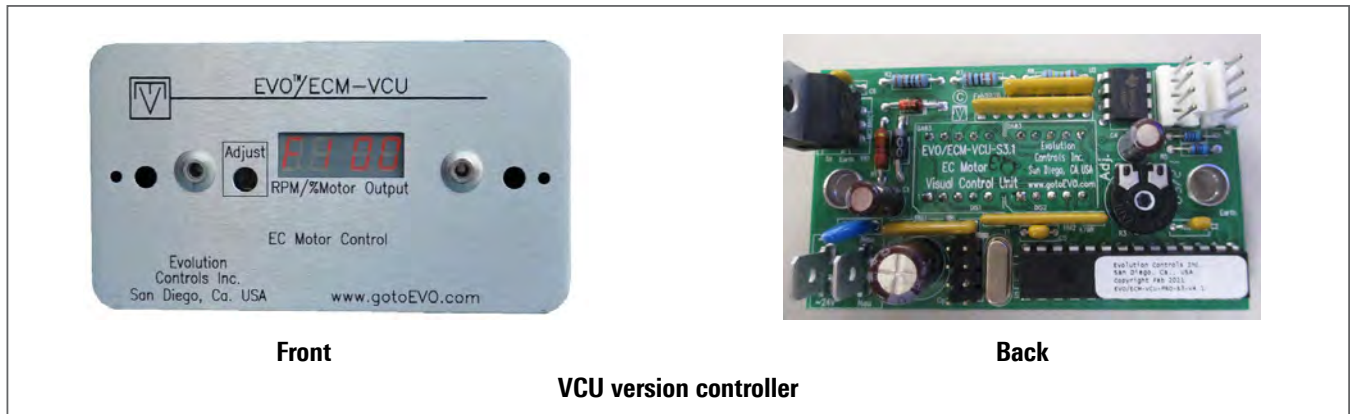
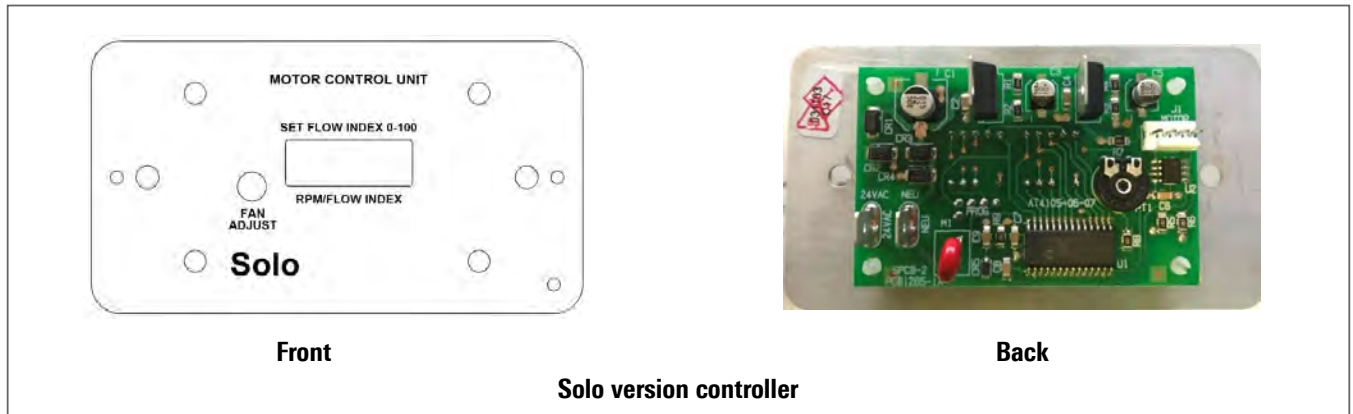

SELECT PWM (FAN COIL, BLOWER COIL)

The Select PWM board allows the user to control an EC motor using multiple speed inputs. It accepts a signal from one of multiple speed commands. The fan speed is selected by applying 24V between the SETx and COM terminals on the PWM board (correlation between fan speed and SETx is listed below). Each of the fan speeds sent to the motor may be adjusted through the position of one of four SETx potentiometers. The speed inputs can come from a thermostat, 3-speed switch, or a discrete jumper used to select speeds. The Select

PWM board will output the selected speeds as a PWM signal to the EC motor. It can be used with fan coil units and blower coil units.

- SET0 = Idle Speed
- SET1 = Low Speed
- SET2 = Medium Speed
- SET3 = High Speed
- SET4 = Not used

ELECTRONICALLY COMMUTATED (EC) MOTOR CONTROL WITH SOLO/VCU, SELECT AND SYNC/ACU PWM BOARDS

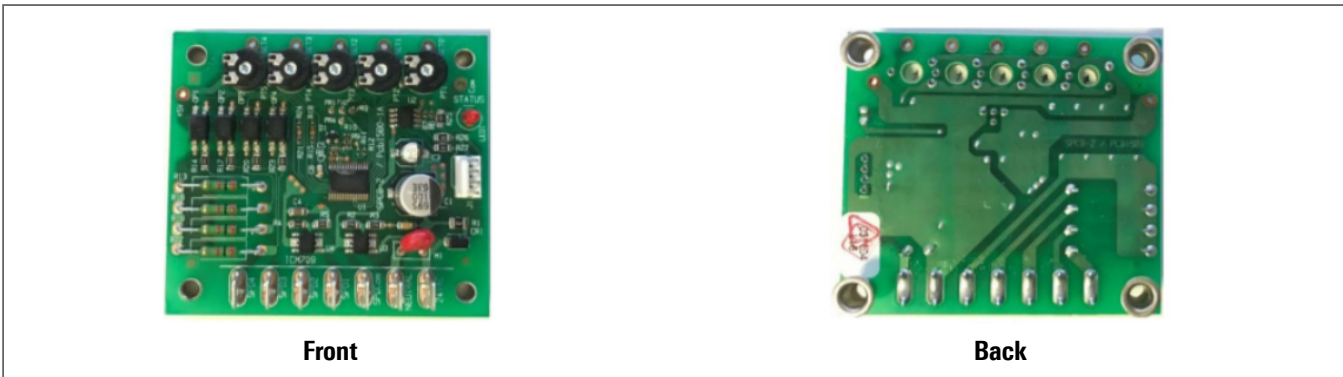

Front

Back

SYNC/ACU PWM (FAN COIL, BLOWER COIL)

The Sync/ACU PWM board allows the user to control an EC motor using an external analog signal, typically from a unit controller. The board will be factory configured for a 2-10VDC signal with jumper installed on the "P" terminals. If the jumper is removed, the board is configured for 0-10VDC. It can be used with fan coil units and blower coil units. To use the Sync/ACU PWM in a manually adjustable single

speed mode, install the jumper on the "M" terminals. The motor control signal will then be controlled by the potentiometer accessible from the front of the board. The PWM percentage can be determined by the "Motor Speed Request" LED on the faceplate, where each long pulse represents 10% duty cycle and each short pulse represents 1% duty cycle.

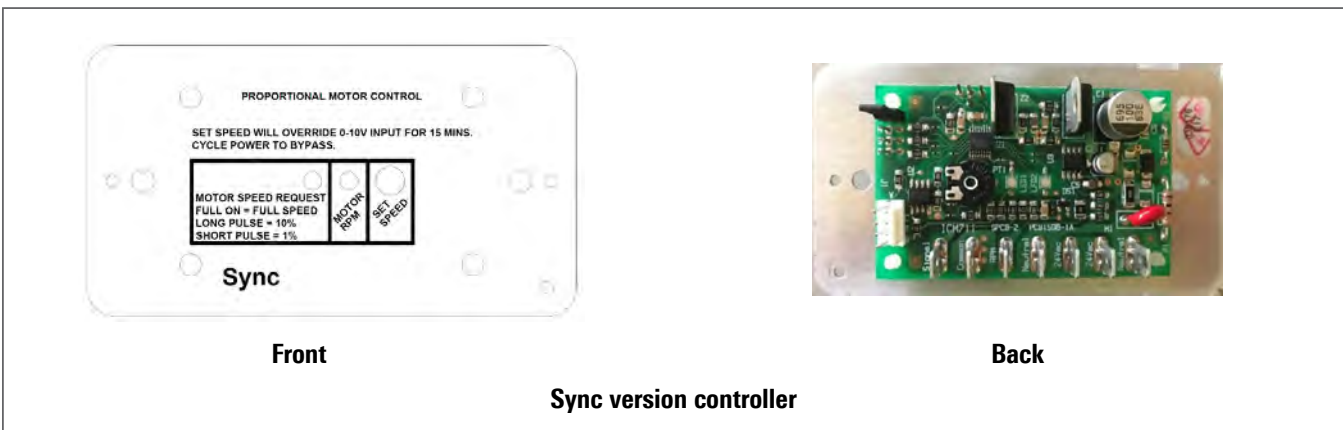

Front

Back

Sync version controller

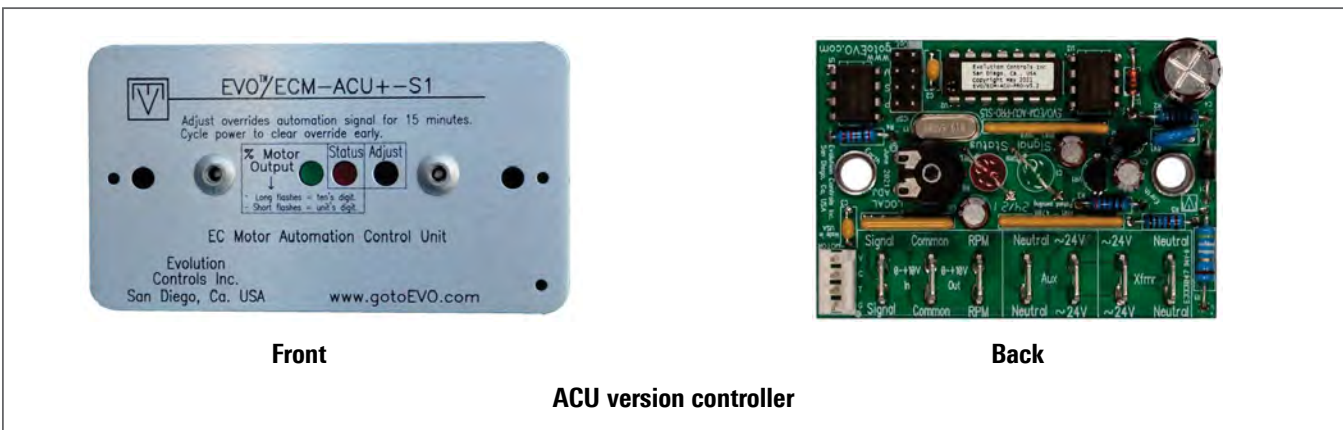

Front

Back

ACU version controller

ELECTRONICALLY COMMUTATED (EC) MOTOR CONTROL WITH SOLO/VCU, SELECT AND SYNC/ACU PWM BOARDS

BALANCING UNITS WITH EC MOTORS

Tools Needed:

- Digital multimeter capable of measuring 30 volts AC/DC and duty cycle (%) with test probes
- Insulated 1/8" flat bladed screwdriver
- 5/64" allen key (if potentiometer adjustment knob is not present on front display panel)

These PWM boards can be adjusted without entering the electrical enclosure (see photo of board installed in an enclosure). Making performance adjustments through the PWM board while the unit is operating is safe and quick. Sample calibration curves are shown below for constant airflow and constant torque motor applications:

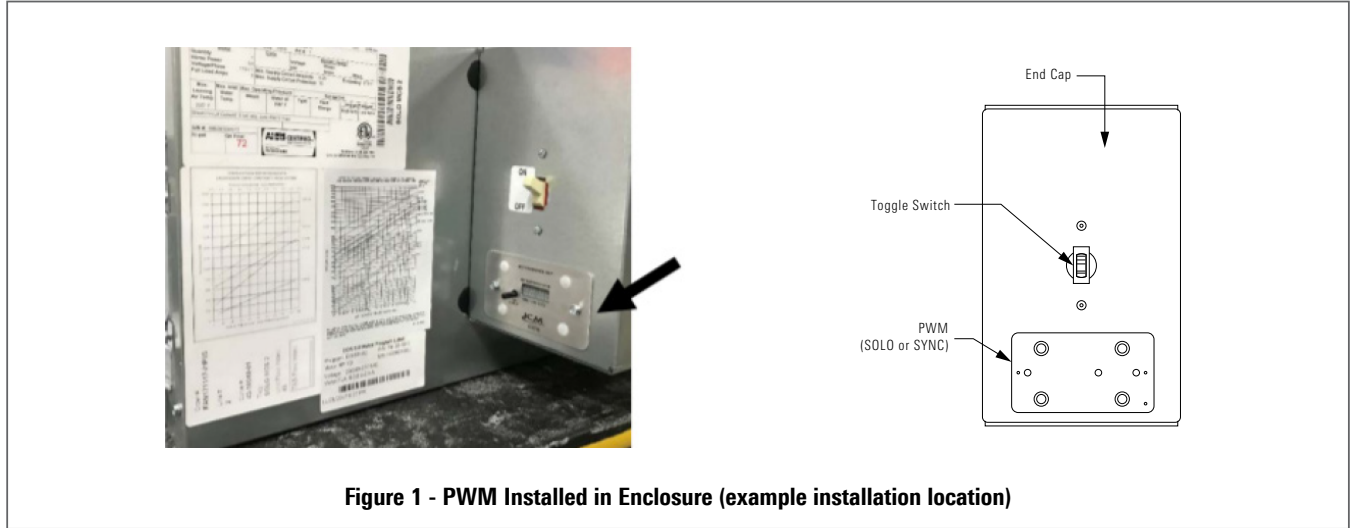

Figure 1 - PWM Installed in Enclosure (example installation location)

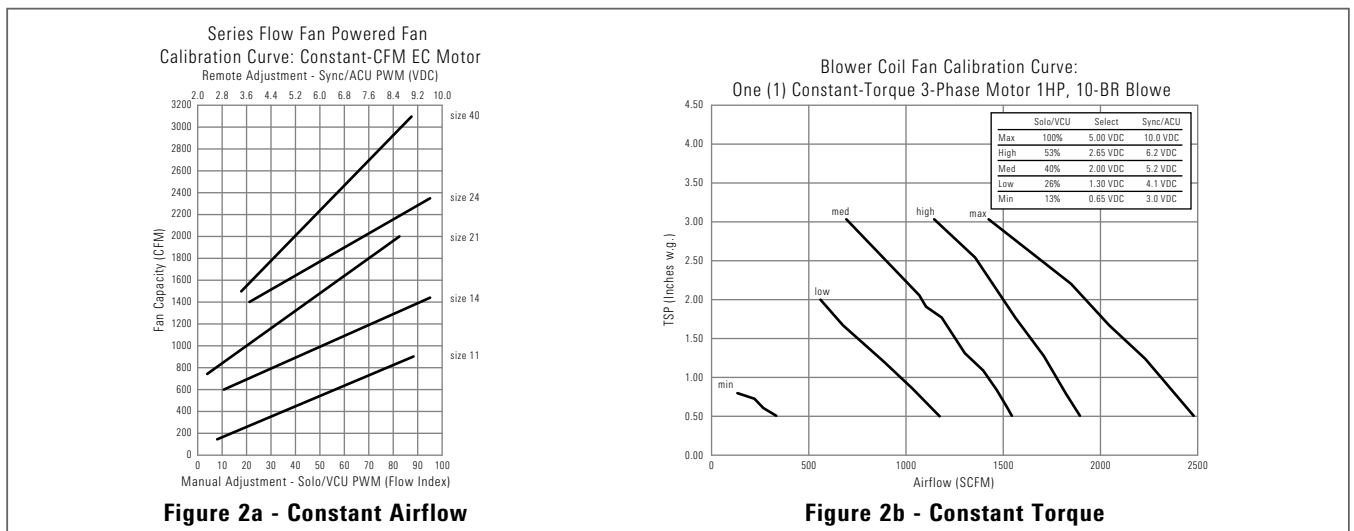

Figure 2a - Constant Airflow

Figure 2b - Constant Torque

SOLO/VCU PWM

1. Make sure there are no obstructions in the discharge ductwork and/or at the plenum opening.
2. Locate the Solo/VCU PWM board, accessible from the outside of the electrical enclosure.
3. Adjust the "Fan Adjust" potentiometer on the front of the PWM board.
4. The fan speed changes and the feedback display shows: "F xx" where "xx" is the duty cycle percentage. This corresponds to the flow index percentage input on the fan calibration curve. For example, on the Size 18 unit in the Calibration Curve above, F70 should correspond to approximately 1200 CFM.
5. Refer to the "Manual Adjustment – Solo/VCU PWM" scale on the fan calibration curve

ELECTRONICALLY COMMUTATED (EC) MOTOR CONTROL WITH SOLO/VCU, SELECT AND SYNC/ACU PWM BOARDS

SELECT PWM

1. Make sure there are no obstructions in the discharge ductwork and/or at the plenum opening.
2. Locate the Select PWM board.
3. Measure the DC voltage between test points SETx and COM. (see

Figures 3 and 4 for location of test points depending on front or back view).

4. **“IDLE” SPEED DETERMINES FAN SPEED WHEN BOARD IS NOT RECEIVING A HIGH, MED, OR LOW INPUT. “IDLE” SHOULD ALWAYS BE SET TO THE LOWEST SETTING.**

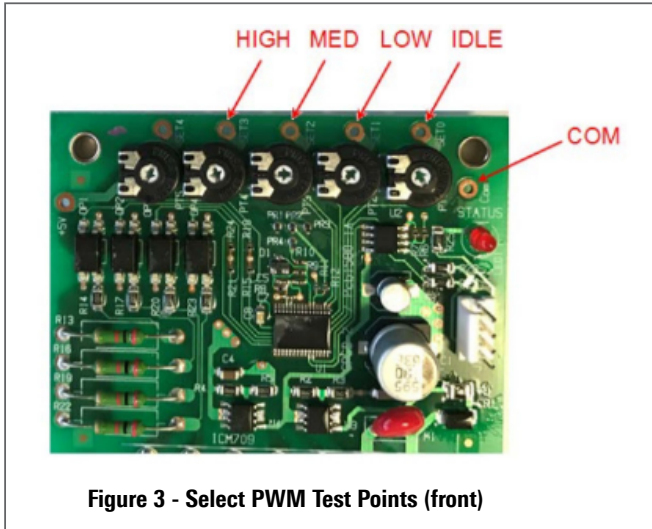

Figure 3 - Select PWM Test Points (front)

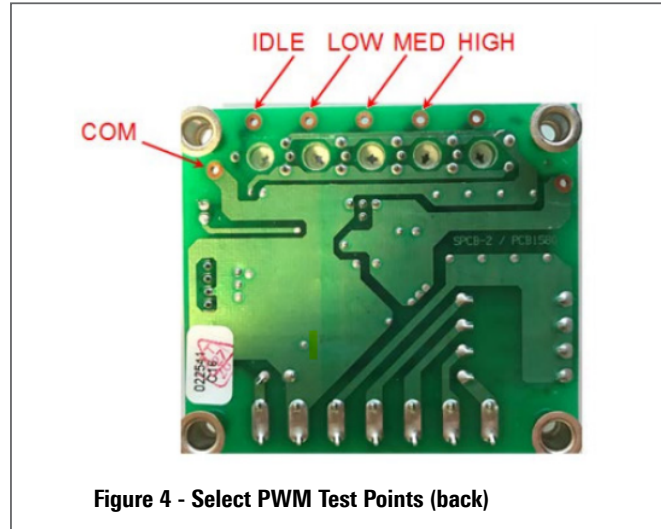

Figure 4 - Select PWM Test Points (back)

5. Adjust the SETx potentiometer to the desired position. The following table correlates the voltage to the output percentage.

NOTE: It is recommended to use an isolated (ungrounded) analog signal and common for the motor control. If used with a float switch, the grounded analog signal will provide a ground path to bypass the float switch when it's tripped, allowing the unit to continue running.

6. Refer to the table on the fan calibration curve label to identify the voltage corresponding to each fan curve.

SET Voltage (DC)	PWM Percentage
0 V	0%
1 V	20%
2 V	40%
3 V	60%
4 V	80%
5 V	100%

SYNC/ACU PWM

1. Make sure there are no obstructions in the discharge ductwork and/or at the plenum opening.
2. Locate the Sync/ACU PWM board, accessible from the outside of the electrical enclosure.
3. The Sync/ACU PWM board accepts a 2-10V signal from its controller. Use the controller to provide the 2-10V signal to achieve the desired airflow. The fan calibration curve includes 2-10V voltages to achieve the desired airflow.
4. Refer to the “Remote Adjustment – Sync/ACU PWM” scale on the fan calibration curve.

5. To override the remote signal:
 - a. Adjust the “Set Speed” potentiometer on the front of the PWM board.
 - b. The controller signal will be overridden for 15 minutes or until power to the PWM board is cycled.

Interpreting “Motor Speed Request” LED:

Each long flash = 10%

Each short flash = 1%

For example, an output of 53% would be represented by 5 long flashes and 3 short flashes. 0% PWM output is represented by an off LED. 100% PWM output is represented by an on LED.

PWM TROUBLESHOOTING GUIDELINES

SOLO/VCU PWM TROUBLESHOOTING GUIDELINES

PWM TROUBLESHOOTING GUIDELINES		
Problem	Possible Cause	Corrective Action
No air flow (No PWM display)	Loss of 24V power	Check 24VAC inputs and power supply.
	Fan Relay is not energized	Verify fan relay is energized (controlled from DDC controller)
	PWM board has failed	Measure PWM signal by measuring PWM signal sent to motor (between PWM (BLK) and COM (WHT)) with digital multimeter set to DC voltage. Adjust PWM signal to observe change in DC voltage. If no voltage is measured, replace PWM
No air flow (with PWM display showing flow index)	Loose or mis-wired motor signal harness between PWM board and motor signal.	Check PWM-motor harness is wired correctly and pins are securely installed
	PWM board faulted	Replace PWM

SELECT PWM TROUBLESHOOTING GUIDELINES

PWM TROUBLESHOOTING GUIDELINES		
Problem	Possible Cause	Corrective Action
No air flow	Loss of 24V power	Check 24VAC inputs and power supply. For units with fan relay boards, refer to Fan Relay Board Troubleshooting Guidelines.
	Motor is malfunctioning or has lost power	Refer to EC Motor Troubleshooting
	PWM board has failed	Measure PWM signal by measuring PWM signal sent to motor (between PWM (BLK) and COM (WHT)) with digital multimeter set to DC voltage. Adjust PWM signal to observe change in DC voltage. If no voltage is measured, replace PWM
Motor runs with no speeds commanded	The SET0 potentiometer determines the PWM signal to the motor when the board is powered but no speed is selected	Adjust SET0 potentiometer to the desired fan speed when no fan speed is commanded.
Motor runs at higher speed than commanded	Multiple speeds are commanded simultaneously. In this instance, the PWM defaults to the highest selected speed.	Remove the simultaneous fan speed commands
Motor doesn't adjust instantly to new speed setting	The PWM board changes its signal by 1% every 0.5 second	Observe that the motor speed is increasing or decreasing and reaches its desired speed within 60 seconds

PWM TROUBLESHOOTING GUIDELINES

SYNC/ACU PWM TROUBLESHOOTING GUIDELINES

PWM TROUBLESHOOTING GUIDELINES		
Problem	Possible Cause	Corrective Action
Motor doesn't run (with no LEDs illuminated)	Loss of 24V power	Check 24VAC inputs and power supply. For units with fan relay boards, refer to Fan Relay Board Troubleshooting Guidelines
	Fan Relay is not energized	Verify fan relay is energized (controlled from DDC controller)
	PWM board has failed	Measure PWM signal by measuring PWM signal sent to motor (between PWM (BLK) and COM (WHT)) with digital multimeter set to DC voltage. Adjust PWM signal to observe change in DC voltage. If no voltage is measured, replace PWM
	Improper or missing 2-10V signal	Verify 2-10V signal from external source (controller, tstat, etc.)
Motor doesn't run (with LEDs illuminated)	Loose or mis-wired motor signal harness between PWM board and motor signal	Check PWM-motor harness is wired correctly and pins are securely installed
	PWM board has failed	Measure PWM signal by measuring PWM signal sent to motor (between PWM (BLK) and COM (WHT)) with digital multimeter set to DC voltage. Adjust PWM signal to observe change in DC voltage. If no voltage is measured, replace PWM
Airflow is slightly higher than expected	PWM board is set up for 0-10V input instead of 2-10V	Verify "P" jumper is installed on the back of the Sync/ACU PWM board

EC MOTOR AND DRIVER

CONSTANT AIRFLOW / CONSTANT TORQUE SINGLE-PHASE EC MOTORS (1/3HP THROUGH 1 HP)

Fan coil and small blower coil product uses this type of EC motor:

- Constant Airflow or Constant Torque EC motor, both single and double shaft.

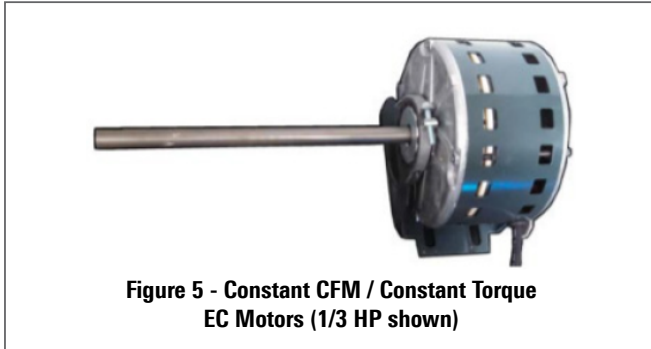

Figure 5 - Constant CFM / Constant Torque EC Motors (1/3 HP shown)



Figure 6 - Constant CFM / Constant Torque EC Motor Driver

CONSTANT CFM / CONSTANT TORQUE EC MOTOR DRIVER CONNECTIONS

Note that connections marked (n/u) are not used.

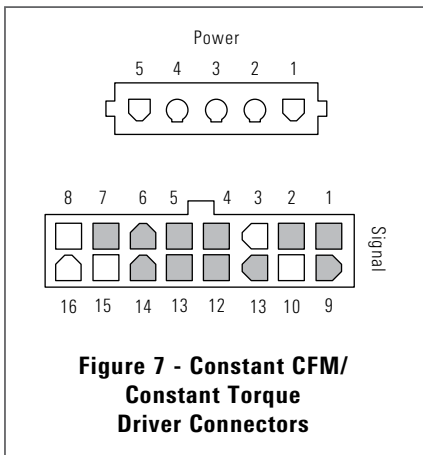

Figure 7 - Constant CFM/ Constant Torque Driver Connectors

Signal Connector	
Pin	Description
1	C1 (n/u - com)
2	W/W1 (n/u)
3	C2 (PWM COM)
4	DELAY (n/u)
5	COOL (n/u)
6	Y1 (n/u)
7	ADJUST (n/u)
8	OUT-(PWM FB)
9	O (n/u)
10	PWM
11	HEAT (n/u)
12	R (n/u)
13	EM/W2 (n/u)
14	Y/Y2 (n/u)
15	G (Fan Enable)
16	OUT+ (PWM FB)

Power Connector	
Pin	Description
1	Jumper pin 1 to 2 for 120 VAC Line Input only
2	
3	Chassis Ground
4	AC Line (line 1)
5	AC Line (Line 2, Neutral)

EC MOTOR AND DRIVER

CONSTANT TORQUE / CONSTANT SPEED SINGLE-PHASE EC MOTORS (1/4 HP)

Small fan coil product uses this type of EC motor:

- Constant Airflow or Constant Torque EC motor, both single and double shaft.

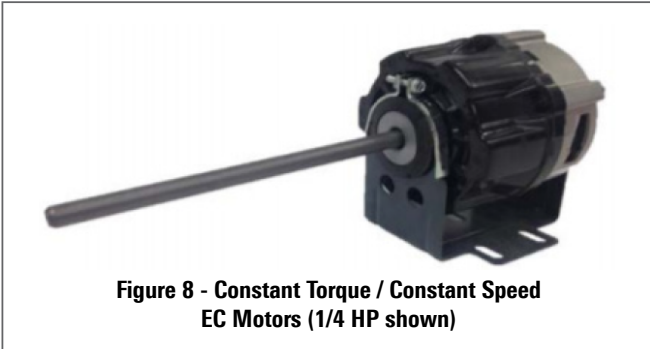

Figure 8 - Constant Torque / Constant Speed EC Motors (1/4 HP shown)

CONSTANT CFM / CONSTANT TORQUE EC MOTOR DRIVER CONNECTIONS

Note that connections marked (n/u) are not used.

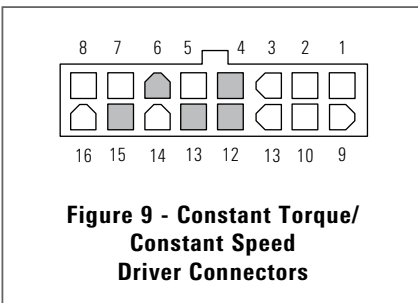

Figure 9 - Constant Torque/ Constant Speed Driver Connectors

Connector	
Pin	Description
1	RUN/ADJUST
2	HIGH
3	LOW
4	(n/u)
5	GND
6	(n/u)
7	NEUT/L2
8	120V Jumper
9	MEDIUM
10	COM
11	TX FEEDBACK
12	(n/u)
13	(n/u)
14	L1
15	(n/u)
16	120V Jumper

EC MOTOR AND DRIVER

CONSTANT TORQUE THREE-PHASE EC MOTORS (1/2 HP THROUGH 1 1/2 HP)

Large blower coil product uses this type of EC motor:

- Constant Airflow or Constant Torque EC motor, both single and double shaft.



Figure 10 - Constant Torque EC Motors (1 HP shown)

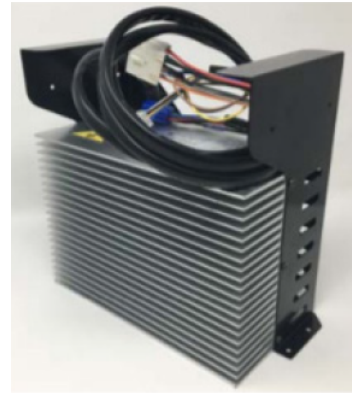
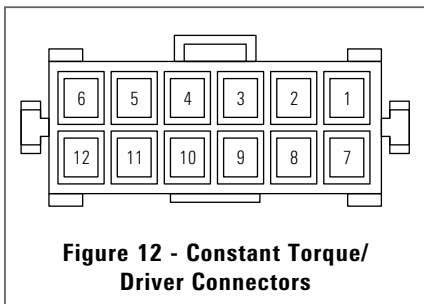

Figure 11 - Constant Torque EC Motor Driver (1.5 HP only)

CONSTANT TORQUE EC MOTOR DRIVER CONNECTIONS

Note that connections marked (n/u) are not used.



**Figure 12 - Constant Torque/
Driver Connectors**

Connector	
Pin	Description
1	RUN/ADJUST
2	HIGH
3	LOW
4	(n/u)
5	GND
6	(n/u)
7	NEUT/L2
8	120V Jumper
9	MEDIUM
10	COM
11	TX FEEDBACK
12	(n/u)
13	(n/u)
14	L1
15	(n/u)
16	120V Jumper

EC MOTOR TROUBLESHOOTING GUIDELINES

Ensure motors and blowers are clean as part of normal maintenance. No further maintenance is required for these motors.

Warning! Follow standard lock out tag out (LOTO) procedures when performing service on motor or blower.

EC MOTOR TROUBLESHOOTING GUIDELINES	
PROBLEM	DETAILED TROUBLESHOOTING INFORMATION
Motor fails to start (no airflow)	Page 12
Motor surges	Page 13
Poor Airflow Performance (low airflow)	Page 13
Fan motor stops but starts	Page 14
Motor speed cannot be adjusted	Page 14
Motor runs in reverse, doesn't respond to speed adjustment	Page 15
Excessive motor noise	Page 15
Motor Overamps or Overloads	Page 16
Checking Wire Harnesses	Page 17

EC MOTOR TROUBLESHOOTING GUIDELINES		
Problem	Possible Cause	Corrective Action
Motor fails to start (no airflow)	No power to motor (possible blown fuse or open circuit breaker)	Verify power to unit. Replace fuse or reset circuit breaker. Verify fuse size.
	Incorrect voltage applied or poor voltage quality	Verify input voltage. Measure phase to phase voltage to verify proper voltage levels per unit label and balanced phases (for 3-phase motors).
	Loose or incorrect wiring connections.	Verify wiring for correct terminations and for tightness of connections. If Fan Coil Relay board present, verify all jumpers and harnesses installed on Fan Relay Board. Refer to Fan Coil Relay Board Troubleshooting Guide.
	Drain pan float switch tripped	If drain pan float switch is present, verify drain pan is not full. Verify operation of float switch. Adjust switch position if needed.
	Fan speed is not commanded	Verify fan run command is present at fan relay/Fan Relay Board.
	Three speed switch in OFF position	Verify three speed switch, if present, is set to desired speed.
	No control signal	Verify PWM signal at motor connector. Refer to PWM board trouble-shooting.
	Low temperature cutout has tripped	Verify voltage at the secondary side of the transformer. If Fan Coil Relay board present, verify all jumpers and harnesses installed on Fan Relay Board. Refer to Fan Relay Board Troubleshooting Guide.
	Damaged or blocked blower	Remove power from unit. Clear blockage. Verify blower is not damaged and rotates freely while motor is not energized.
	Motor seized	Remove power from unit. Verify motor rotates freely by hand. If not, replace motor.
	Motor Failure	Replace motor.
Motor overloaded	Verify motor is not overheated. Remove power from unit. Check to ensure blower rotates freely with motor disconnected. Verify proper duct static. Wait for motor to cool down and verify motor start. If motor overheats again, replace motor.	

EC MOTOR TROUBLESHOOTING GUIDELINES

EC MOTOR TROUBLESHOOTING GUIDELINES		
Problem	Possible Cause	Corrective Action
Motor fails to start (no airflow)	EC wiring harness improperly seated	Unplug harness and re-install, making sure plugs are fully seated.
	PWM board fault	Verify PWM signal at motor connector. Refer to PWM board trouble- shooting.
	Wiring harness(es) open or intermittent	Replace harness(es). See section on checking wire harnesses.
	Drain pan float switch fault	Verify operation of drain pan float switch, if present. Disconnect switch and use volt-ohm meter to verify continuity of switch and of wiring. Replace switch if faulty.
	Damaged motor cable	If the cable is integral to motor, replace motor.
Motor surges	Fan speed adjustment outside operating range	Refer to Fan Calibration curve on unit. Adjust speed on PWM Controller to value that will allow motor to start. See instructions for Adjusting EC Motor Speed.
	Blower Set Screw loose	Tighten Screw onto motor shaft.
	ESP (external static pressure) too high	Verify dampers, if present, are not closed. Verify there are no obstructions in the discharge ductwork and/or at the plenum opening. Verify filter is not dirty and does not obstruct airflow.
	PWM board fault	Verify PWM signal at motor connector. Refer to PWM board trouble- shooting
	Improper duct connections	Verify proper ductwork to unit. Verify ductwork is installed per SMACNA and ASHRAE guidelines. Incorrectly sized ducts can cause motor surging.
	Intermittent control device	Verify operation of any control device such as drain pan float switch, low temperature cutout, thermostat, etc. When in doubt, jumper out and verify fan operation.
	Loose wiring	Reseat harness connections. Verify and/or tighten all wire connections.
Poor Airflow Performance (low airflow)	Incorrect Blower Rotation (1-phase motors)	Verify blower rotation (see rotation label on blower coil units).
	Incorrect Blower Rotation (3-phase motors)	Verify blower rotation (see rotation label on blower coil units). If motor rotates backwards, disconnect power from unit. Reverse rotation via connecting or disconnecting motor turn reversal connectors (orange and gray) on motor wire harness.
	Fan speed adjustment outside operating range	Refer to Fan Calibration curve on unit. Adjust speed on PWM Controller to value that will allow motor to start. See instructions for Adjusting EC Motor Speed.
	3-speed control - wrong speed is selected	If present, verify three speed control is set to desired speed.
	Proportional control - improper speed command is sent to motor	Verify 2-10V control signal to PWM board. See PWM board troubleshoot- ing.
	Damaged or blocked blower	Remove power from unit. Clear blockage. Verify blower is not damaged and rotates freely while motor is not energized
	Dirty filters	Check for dirty or blocked filters throughout attached ductwork. Replace as needed.
	Dirty coil	Check cleanliness of water coil. Dirty or clogged water coil fins will restrict airflow.
	Blower Set Screw loose	Tighten Screw onto motor shaft.
	Lack of required external static pressure	External static pressure not as designed. Adjust external static pressure to design pressure
Improper duct connections	Verify ductwork is installed per SMACNA and ASHRAE guidelines.	

EC MOTOR TROUBLESHOOTING GUIDELINES

EC MOTOR TROUBLESHOOTING GUIDELINES		
Problem	Possible Cause	Corrective Action
Poor Airflow Performance (low airflow)	Improperly set dampers	Verify duct dampers installed and in proper open position. Verify automation system controlling dampers per plan.
	Duct obstruction	Verify no obstructions. Verify all dampers are full open while fan operates
	System improperly balanced	Verify system properly balanced. Verify no excess system loss. Verify no airflow through unit when blower is stopped. This could cause motor/ blower to windmill.
	PWM board fault	Verify PWM signal at motor connector. Refer to PWM board troubleshooting.
Motor surges	Incorrect voltage applied or poor voltage quality	Verify input voltage. Measure phase to phase voltage to verify proper voltage levels per unit label and balanced phases (for 3-phase motors).
	Loose or incorrect wiring connections.	Verify wiring for correct terminations and for tightness of connections. If Fan Coil Relay board present, verify all jumpers and harnesses installed on Fan Relay Board. Refer to Fan Coil Relay Board Troubleshooting Guide.
	Motor Failure	Replace motor.
	Excess Temperature	Verify temperatures in blower compartment/airway are not higher than design (104°F max.)
Fan motor stops but starts	Voltage or ground loss at motor/driver.	Verify proper voltage and ground at motor or driver power terminals. Refer to motor/driver connections for the EC motor.
	Damaged or blocked blower	Remove power from unit. Clear blockage. Verify blower is not damaged and rotates freely while motor is not energized.
	Loss of fan speed command	Verify fan speed is commanded/enabled from thermostat, three speed switch or controller. If Fan Coil Relay board present, verify fan speed command at relay board. Refer to Fan Relay board troubleshooting guide.
	PWM board fault	Verify PWM signal at motor connector. Refer to PWM board troubleshooting.
	Open ductwork	Verify ductwork sealed properly
	Motor overloaded	Use amp meter to verify motor amps. Disconnect power from unit. Verify motor rotates freely by hand with blower disconnected. If not, replace motor.
	Motor overheated due to lack of airflow	Verify dampers, if present, are not closed. Verify there are no obstructions in the discharge ductwork and/or at the plenum opening. Verify filter is not dirty and does not obstruct airflow
	Damaged motor cable	Reseat connector and verify operation. Disconnect motor harnesses and verify continuity. Replace harness. If cable is integral to motor, replace motor.
	Motor driver failure	Replace motor driver. If driver is integral to motor, replace motor.
	Motor Failure	Replace motor
Motor speed cannot be adjusted	PWM board fault	Verify PWM signal at motor connector. Refer to PWM board troubleshooting
	No control signal	Refer to PWM troubleshooting guidelines
	Loose or incorrect wiring connections	Verify wiring for correct terminations and for tightness of connections. If Fan Coil Relay board present, verify all jumpers and harnesses installed on Fan Relay Board. Refer to Fan Coil Relay Board Troubleshooting Guide.

EC MOTOR TROUBLESHOOTING GUIDELINES

EC MOTOR TROUBLESHOOTING GUIDELINES		
Problem	Possible Cause	Corrective Action
Motor speed cannot be adjusted	EC wiring harness improperly seated	Unplug harness and re-install, making sure plugs are fully seated
	Wiring harness(es) open or intermittent	Replace harness(es). See section on checking wire harnesses.
	ESP (external static pressure) too high	Verify dampers, if present, are not closed. Verify there are no obstructions in the discharge ductwork and/or at the plenum opening. Verify filter is not dirty and does not obstruct airflow
	Motor driver failure	Replace motor driver. If driver is integral to motor, replace motor.
Motor runs in reverse, doesn't respond to speed adjustment	Incorrect Blower Rotation (1-phase motors)	Verify blower rotation (see rotation label on blower coil units).
	Incorrect Blower Rotation (3-phase motors)	Verify blower rotation (see rotation label on blower coil units). If motor rotates backwards, disconnect power from unit. Reverse rotation via connecting or disconnecting motor turn reversal connectors (orange and gray) on motor wire harness.
	Motor driver failure	Replace motor driver. If driver is integral to motor, replace motor.
Excessive motor noise	Motor mounting bolts loose	Tighten motor mounting bolts
	Blower Set Screw loose	Tighten Screw onto motor shaft
	Fan Wheel Off Center (rubbing on housing)	Verify blower/wheel and motor alignment
	Loose fan wheel	Align and tighten
	Damaged or imbalanced fan wheel	Inspect fan wheel to verify fins are not bent. Replace blower as needed.
	Dirty filters	Verify filters. Replace as needed.
	Obstructed airflow	Verify blower is unobstructed. Verify no duct obstruction. Verify dampers are full open.
	Improper duct connections	Verify ductwork is installed per SMACNA and ASHRAE guidelines
	Static pressure too low	Verify static pressure per system design.
	Improperly balanced system	Verify system properly balanced. Verify no airflow with fan stopped.
	Incorrect voltage applied or poor voltage quality	Verify input voltage. Measure phase to phase voltage to verify proper voltage levels per unit label and balanced phases (for 3-phase motors).
	PWM board fault	Verify PWM signal at motor connector. Refer to PWM board trouble-shooting.
	Motor shaft bent	Verify wiring for correct terminations and for tightness of connections. If Fan Coil Relay board present, verify all jumpers and harnesses installed on Fan Relay Board. Refer to Fan Coil Relay Board Troubleshooting Guide.
	EC wiring harness improperly seated	Unplug harness and re-install, making sure plugs are fully seated
	Wiring harness(es) open or intermittent	Replace harness(es). See section on checking wire harnesses.
ESP (external static pressure) too high	Verify dampers, if present, are not closed. Verify there are no obstructions in the discharge ductwork and/or at the plenum opening. Verify filter is not dirty and does not obstruct airflow	
Motor driver failure	Replace motor driver. If driver is integral to motor, replace motor.	

EC MOTOR TROUBLESHOOTING GUIDELINES

EC MOTOR TROUBLESHOOTING GUIDELINES		
Problem	Possible Cause	Corrective Action
Excessive motor noise	Motor overloaded	Use amp meter to verify motor amps. Verify static pressure within limits shown on Fan Calibration Curve on unit. Verify motor rotates freely with power disconnected. If not, replace motor.
	Motor Bearing (end of life)	Disconnect power from unit. Verify motor rotates freely by hand with blower disconnected.
	Motor Failure (end of life)	Replace motor
Motor Overamps or Overloads	Low Duct Static Pressure	Verify proper static in the duct work. Low static will cause the motor to overamp. Reduce motor rpm to compensate.
	Duct Leakage	Verify duct work. Duct leakage will cause low static that will cause the motor to overamp. Loose duct work could cause duct obstruction.
	Improperly set dampers	Verify duct dampers installed and in proper open position. Verify automation system controlling dampers per plan. Verify system properly balanced. Try closing off some dampers to increase duct static.
	Improperly balanced system	Verify system properly balanced. Verify no airflow with fan stopped.
	Damaged or blocked blower	Remove power from unit. Clear blockage. Verify blower is not damaged and rotates freely while motor is not energized.
	Incorrect Blower Rotation (1-phase motors)	Verify blower rotation (see rotation label on blower coil units).
	Incorrect Blower Rotation (3-phase motors)	Verify blower rotation (see rotation label on blower coil units). If motor rotates backwards, disconnect power from unit. Reverse rotation via connecting or disconnecting motor turn reversal connectors (orange and gray) on motor wire harness.
	Line Reactor/Inductor Connections (large motors only)	Verify line reactor/inductor is connected properly per wiring diagram
	Incorrect voltage applied or poor voltage quality	Verify input voltage to ECM. Measure phase to phase voltage to verify proper balance. Verify no line surges or dips. Verify no ground faults. Verify no condensation on power wires
Motor Bearing Failure	Shut off power to motor. If bearing is excessively hot after power re- moved, bearing may have failed. Replace motor.	

EC MOTOR TROUBLESHOOTING GUIDELINES

CHECKING EC WIRE HARNESSSES

Use ohmmeter to verify that motor ground wire has continuity from motor case to ground.

To check signal wire harnesses

- Remove power from the unit. Unplug signal harness at EC driver and from motor connector at PWM board.
- Use ohmmeter to check continuity for each conductor, then reconnect harnesses to driver and to PWM board.

To check power wire harnesses:

- Refer to wiring diagram.
- Remove power from the unit. Unplug power harness at EC driver.
- Verify green wire has continuity to ground.
- Unplug power wires from connections in electrical enclosure. Verify continuity of wires to motor driver, then reconnect to same terminals.

Before reconnecting power to unit, verify all harnesses are connected per diagram.

Use light force when inserting meter probe into plug. Excess force will damage contacts.

EC MOTLINES		FCU				BCU
PWM↓	Model→	THB Series A	TVB	THH Series A	TVS	TBHD/TBVD
Solo/VCU => Sync/ACU		-	-	-	-	66-13087-01
Sync/ACU => Solo/VCU		-	-	-	-	66-13087-02
Select => Solo/VCU		-	-	-	-	66-13087-04
Select => Sync/ACU		66-13085-01 *	66-13084-01	66-13089-01	66-13088-01	66-13087-05
Solo/VCU/Sync/ACU => Select		66-13085-02 *	66-13084-02	66-13089-02	66-13088-02	66-13087-03
* Applies to THB Series A units shipped 2020 and later. To convert units that shipped in 2019 or earlier, contact factory.						

